



Meat processing machines

Precision for a fresh variety

BIZERBA





The Open World of Finest Weighing Solutions. Since 1866.

Our experience sets standards

We are a family-owned company guided by a commitment to tradition, sustainability and responsibility. Nowadays, based on our core competence of slicing and weighing technology, we offer our customers the industry's largest and most unique range of products and solutions as hardware, software and services, anywhere in the world.

As a globally operating technology company we are guided by our goal and commitment to achieve maximum results in terms of ergonomic design, hygiene, safety and efficiency. We believe we have a role to play in shaping our markets, and are continually setting new industry standards.

In close collaboration with our customers and against a backdrop of technological advancement, we are working to improve our products on a daily basis - resulting in innovations which become new standards.

In order to continue to live up to these requirements, we focus on the highest possible quality standards and internationally recognized technology standards in our development and manufacturing work. This is how we best support our customers in achieving maximum efficiency and profitable growth.

Our experience sets standards.

That's what sets us apart. Bizerba



Simply higher performance

For our meat processing machines, safety, ergonomics and hygiene are perfectly combined. The result: Optimum product quality which is reflected in your customers' satisfaction.

The high quality of our meat processing machines enables you to take a decisive step forward in your industry. A step which brings you closer to your own vision, your customers' wishes and, last not least, your commercial success. Our carefully developed and practically oriented solutions provide you with additional benefits which go beyond simple cutting, portioning and refining of meat.

You can look forward to efficient handling during every stage of production. Secure a safety concept well above the standard for you and your staff. You can offer your customers a broad range of diverse meat, fish, cheese or vegetable products which you can gently process as fresh ingredients. This creates value in the truest sense of the word – for quality which you can see, smell and taste.

Perfectly aligned

Our meat processing machines can be ideally integrated in your processes. They have a high-quality and durable execution in stainless steel; they are flexible and space-saving as well as extremely versatile in application. This makes them perfect team players for your industry, tasks and products.



Sawing, portioning

FK23

Compact saw for retail, trade, the restaurant and catering industry

FK32

Flexible saw system for industrial applications

Applications

Comminution and portioning of fresh, frozen and smoked food, meat with and without bones, fish



Mincing

FW N22/82

Compact meat mincer for retail, trade, the restaurant and catering industry

FW N32/98

Tabletop or stand-alone device for retail, trade and industry

Applications

Mincing of fresh, cooked and smoked food, Meat (e.g. marbled, hot or cold meat) such as bacon, offal, rind and vegetables



Strip cutting, tenderizing, pressing, knitting

S111

Multifunctional device for retail, trade, the restaurant and catering industry

S121

Multifunctional device for industrial applications

Applications

Cutting and tenderizing of fresh meat, cold meat and sausages, cheese and vegetables

Create real values



Precision and variation

As a result of the consistent focus on the requirements of your production, we have considered every detail which is relevant for precise and ergonomic work in developing our meat processing machines. Our compact meat and bone saw FK23 is designed for right-handed operation. Your benefit: You can guide the product easily and, in particular, safely during cutting and portioning. The scale integrated into the work table ensures precise and uniform cuts. These are ideal preconditions for efficient and ergonomic work, e.g. in the production of chops. The variable use of saw blade permits a broader range of possible uses. Moreover, high-quality products such as high-quality fish or matured beef are processed with the FK23 without major sawing losses and so as to ensure that the product is visually attractive.

Safety

In designing this product family we have placed high value on work safety. The flexible saw system FK32 offers you maximum prevention. Combined with the height-adjustable blade guard and the saw blade guide, the ergonomic product guidance and the optimized product pusher ensure the highest possible ergonomics, precision and safety – during every production stage – and day by day. Day after day. A gas pressured spring permits safe and fast replacement of the saw blades. The fast motor circuit breaker and stable, large feet for tilt resistance ensure increased security during on-going operation.

Quality

We fulfil even the highest requirements in the particularly sensitive areas of meat processing. And you can experience this outstanding quality of our devices during mincing, for example. Excellent quality from which your customers can also benefit. With the meat mincer FW N32/98 you gently process meat to ground meat or Tatar – without squeezing or warming it up. The perfect result of your value creation: A loose, fluffy structure, a longer lasting naturally red color because of the increased oxygen enrichment and improved shelf-life of your products. It is the ideal solution for all those who attach importance to high-quality, fresh ingredients.

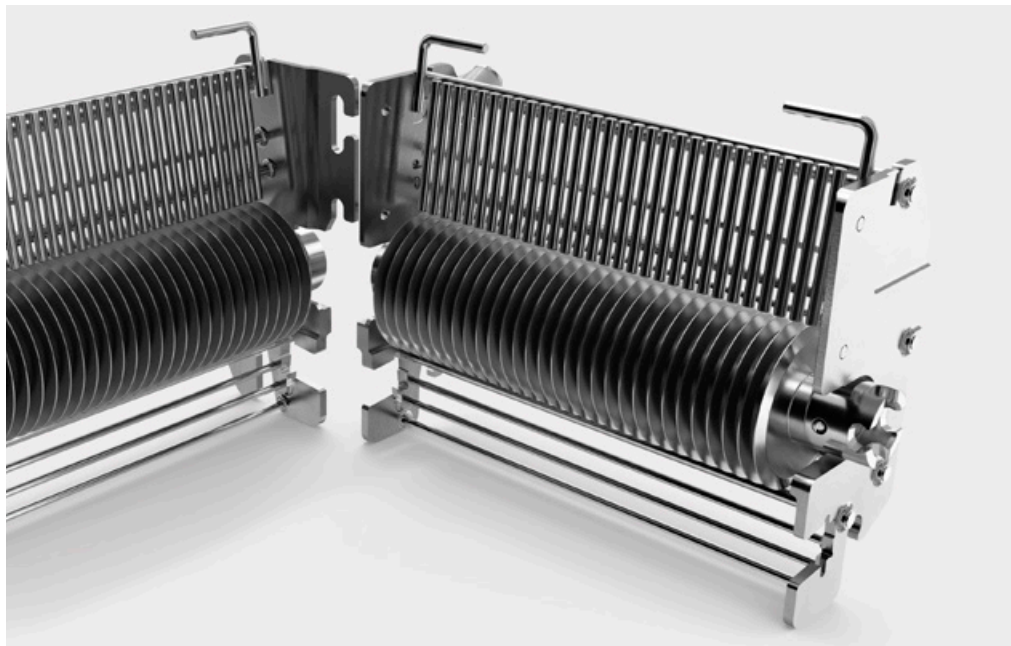

Hygiene

Made of stainless steel and of an edgeless design, the meat processing machines fulfil even the highest requirements put to hygiene and also allow efficient cleaning. This also applies to mincing. In the meat mincer FW N22/82, feed pan and feed hopper are seamlessly welded to the take-up of the worm. The feed pan itself is tailored to hygienic meat processing: The floor is made of one piece and has a funnel shape. Your benefit: They can process the product quickly and hygienically. After use, the entire cutting system can be taken off in one go and then cleaned in an easy and straightforward manner.

Ergonomic design

Achieving a perfect result with only a few and simple steps – this is the aim of our meat processing machines. The strip cutter and tenderizer S111 is the best example of user-friendly ergonomics. A high performance multifunctional and ergonomic device for strip cutting, tenderizing, pressing and knitting. For effective work, you mount the cutting sets in an easy and safe manner without tools or a screw top and process your products directly into a gastronorm tray. Moreover, you will find the simple handling impressive – even in cleaning the cutting set. It consists of only two easily dismantled parts which can be cleaned hygienically without effort even in the interspaces.

Emotion*

The S121 is special proof of our outstanding engineering skills. In refining your products, the motor adjusts its output to the resistance of the food using the intelligent Emotion® control system. The added value created for you: The efficient motor use permits production in continuous operation and, at the same time, the lowest possible electricity costs. Moreover, you can also increase the quality of your products with the S121. Compared with standard devices, the machine surface stays cooler and your product will stay fresh for longer. The best form for efficient and low-noise value creation.



Option bench type stand with feet

Meat and bone saw FK23

Highlights

- Perfectly suitable for sales counter or preparation room
- Robust stainless steel design, edgeless welded
- Easy saw blade quick-tensioning system for ergonomic fixing and fast replacement
- Electronics integrated in housing: Ideal protection against mechanic damage or damage resulting from water
- High hygienestandard: Solid saw wheels
- Easy and effective cleaning:
 - Removable blade and wheel scrapers
 - Cleaning with hose water due to IP55
- Ergonomic operation: Product guidance with right hand
- Sophisticated safety concept for a minimized risk of injury:
 - Optimized product pusher
 - Height adjustable blade guard and blade guide
- Constant slice thickness: Integrated scale on the work table

Options

- Enlarged work table
- Stainless steel bench type stand with feet
- Various saw blades:
 - Universal
 - Konwe: Minimizes chipping for product without solid bones

Dimensions

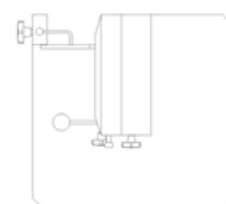
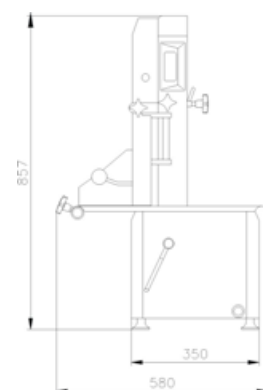



Meat and bone saw FK32

Highlights

- Perfect for industrial use as a result of its design and numerous different versions
- Robust stainless steel design, edgeless welded
- Easy saw blade quick-tensioning system for ergonomic fixing and fast replacement
- Electronics integrated in housing: Ideal protection against mechanic damage or damage resulting from water
- High hygienestandard: Solid saw wheels
- Easy and effective cleaning:
 - Removable blade and wheel scrapers
 - Cleaning with hose water due to IP55
- Ergonomic operation: Product guidance with right hand
- Sophisticated safety concept for a minimized risk of injury:
 - Optimized product pusher
 - Height adjustable blade guard and blade guide
- Constant slice thickness: Integrated scale on the work table

Options

- Sliding table with removable remnant holder
- Mobile version
- Various saw blades:
 - Universal
 - Konwe: Minimizes chipping for product without solid bones
 - Band blades: Avoid chipping for product without bones

Dimensions

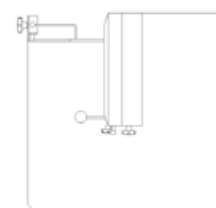
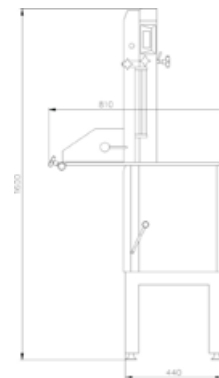



Mincer FW N22/82

Highlights

- Compact meat mincer for sales counter and preparation room
- Robust design: Stainless steel housing and thick-walled product feed pan
- Longer product life:
 - Free of play clearance for gentle comminution
 - No warming up and high oxygen enrichment
- High hygienestandard:
 - Feed pan without folded upper edge
 - Seamlessly welded: Feed pan and feed hopper with worm housing take-up
- Efficient conveying: Optimized worm shape, almost no re-feeding
- High safety: Operation only possible with properly installed worm housing
- Easy and effective cleaning: Easily removable mincing insert

Options

- Large product feed pan: Fill volume 13.5 l
- Splash guard
- Fly cover flap
- Various cutting sets:
 - L+W longlife: Enterprise, 2-part
 - L+W: Unger, 3- or 5-part
 - Lico: Unger, 3- or 5-part, replaceable blades
 - Auja: Unger, 3- or 5-part

Dimensions

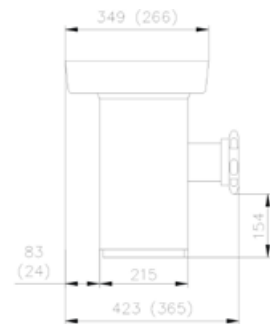
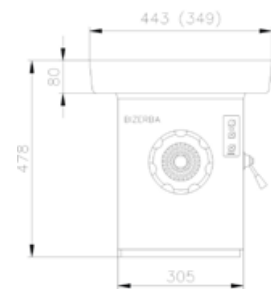



Mincer FW N32/98

Highlights

- Ideal in the preparation room as a tabletop or stand-alone device
- Longer product life:
 - Free of play clearance for gentle comminution
 - No warming up and high oxygen enrichment
- Particularly large one-piece feed pan
- High hygienestandard: Feed pan without folded upper edge
- Efficient conveying: Optimized worm shape, almost no re-feeding
- Easy and effective cleaning: Easily removable mincing insert
- Robust design: Stainless steel housing and thick-walled product feed pan

Options

- Tabletop and stand version, also mobile variant available
- Mobile with 2 or 4 castors
- Splash guard
- Various cutting sets:
 - L+W longlife: Enterprise, 2-part
 - L+W: Unger, 3- or 5-part
 - Lico: Unger, 3- or 5-part, replaceable blades
 - Auja: Unger, 3- or 5-part

Dimensions

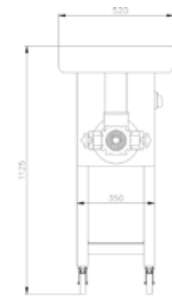

FW N32/98



Tenderizing set

Tenderizer/strip cutter S111

Highlights

- Multifunctional device for use in trade: Strip cutting, tenderizing, pressing and knitting with a single device
- Easy cleaning:
 - Cutting sets can be removed with ease without the need for tools or threaded connectors
 - Hygienic cleaning between the blades: Two-part, detachable cutting set
- Safe handling:
 - Compact, tilt-proof
 - Transparent, plastic protective cover ensures high visibility
- Simple and productive feed-through even of big products: Large and seamlessly integrated feed opening
- Direct cutting into a Gastronorm tray or other containers

Options

- Attachable feed pan
- Gastronorm tray
- Stand with shelf for E2 box
- Stripping combs for product throughput of 21 mm and 30 mm
- Handle on the cutting set for even more secure and ergonomic handling
- Various sets:
 - Tenderizing set S011: Reduces the frying time of steaks and schnitzels
 - Knitting set S012: Deeper cutting for minimized frying time, two pieces of meat can be knitted into one
 - Strip cutter set S021: Communion in even strips of variable strip thicknesses

Dimensions

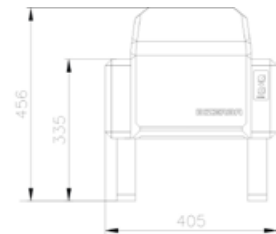
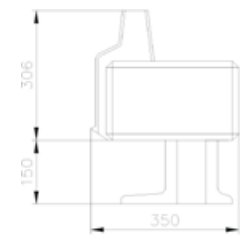



Stand with shelf for E2 box

Tenderizer/strip cutter S121

Highlights

- Multi-functional device for industrial continuous operation: Strip cutting, tenderizing, pressing and knitting
- Easy cleaning:
 - Cutting sets can be removed with ease, no need for tools or threaded connectors
 - Hygienic cleaning between the blades: Two-part, detachable cutting set
- Safe handling:
 - Compact, tilt-proof
 - Transparent, plastic protective cover ensures high visibility
- Simple and productive feed-through even of big products: Large and seamlessly integrated feed opening
- Direct cutting into a Gastronorm tray or other containers
- Can be integrated into automated production lines for convenience products

Options

- Product chute for automatic feeding from the conveyor belt
- Attachable feed pan
- Gastronorm tray
- Stand with shelf for E2 box
- Stripping combs for product throughput of 21 mm and 30 mm
- Handle on the cutting set for even more secure and ergonomic handling
- Various sets:
 - Tenderizing set S011: Reduces the frying time of steaks and schnitzels
 - Knitting set S012: Deeper cutting for minimized frying time, two pieces of meat can be knitted into one
 - Strip cutter set S021: Gentle comminution into variable strip thicknesses

Dimensions

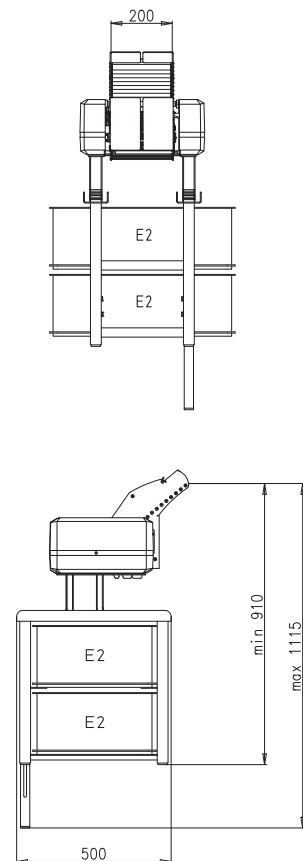

All possibilities at a glance

	FK23	FK32	FW N22/82	FW N32/98	S111	S121
Ideal for						
Sausages/cold cuts	×	×	×	×	●	●
Meat, fresh	●	●	●	●	●	●
Ham with bones	●	●	×	×	×	×
Cheese	×	×	×	×	⊖	⊖
Fruit/vegetables	×	×	⊖	⊖	●	●
Application						
Pre-slicing	●	●	⊖	●	●	●
Presentation	×	×	×	×	⊖	⊖
Assisted sales	⊖	×	●	×	×	×
Application area						
Retail area (counter)	●	×	●	×	⊖	×
Canteen kitchen/restaurant	●	×	●	⊖	●	●
Industrial	×	●	×	●	×	●
Dimensions						
Installation area				Table top		
Width × Length [mm]	350 × 360	440 × 500	215 × 305	515 × 316	345 × 260	–
				Standversion		
				521 × 360		
Max. product sizes						
Width × Length [mm]	190 × 250	290 × 330	–	–	195 × 30	195 × 30

Legend

- Suitable for use
- ⊖ Possibly suitable for use for the respective application
- ×

For top quality and reliable performance



Rely on high-quality cleaning products and original consumables in Bizerba quality in your day-to-day work with your meat processing machine. Everything is perfectly matched to your products ensuring best possible results and longevity of your investment. A perfect example of teamwork with added benefits for you.

Optimal functioning and constant availability of your devices and machines requires professional care. Our

high quality cleaning agents play an important role here since they are specifically developed for demanding conditions in retail, industry and food service. They are easy to use and show impressive results: perfect cleanliness providing protection as well as disinfecting hygiene for sensible components and smooth surfaces. For each material whether stainless steel, plastic or glass, we have a suitable cleaning agent in our comprehensive assortment. Clean solutions for your work area or production facility.

Our service Professional on-site support



We supplement the use of our Bizerba models with optimal service. Benefit from our experience and industry know-how. Our highly qualified service experts are at your service nationwide.

In order to obtain the maximum from your investments we are there for you with a multi-level service. This includes advice, start-up and installation of the meat processing machines as well as other services. Our perfectly matched modules ensure continuous availability.

Service modules

- Individually agreed service contracts
- Start-up including initial training and initial installation
- 24/7 service contract, optional
- Full support (spare parts, technical competence and on-site support)
- Large nationwide network of service experts who are quickly at your service and on-site
- A broad range of cleaning and care products
- Service hotline
- Customer training

Information to suit your every need

If you are looking for a fast and reliable way to find the right solutions for your company, there are various routes to the perfect result. Whether you would like to contact us online or prefer to arrange a face-to-face meeting, Bizerba is always happy to help.

In person

You personally want to inform yourself about solutions tailored to your local circumstances? Do not hesitate to contact us. Our customer advisors are always on hand to assist you. From the idea of planning measures up to the implementation and training, our customer service representatives are at your service. You can find details of how to contact us on the back page of this brochure.

Online

The Bizerba website provides a quick, easy and focused overview of all our product solutions as well as relevant topics relating to weighing,

packaging, pricing and labeling. Experience our solutions from all sides. Our solutions can be viewed virtually in a short video or 360° animation. Simply visit our website to see more:

www.bizerba.com

Would you like to learn more?

Are you keen to obtain more detailed information about Bizerba's products? If so, please contact us. Whether these are dimensional drawings, technical information or interface descriptions. We are happy to advise you.

Members of the Bizerba Group

Bizerba SE & Co. KG

Wilhelm-Kraut-Straße 65
72336 Balingen
Germany

T +49 7433 12-0
F +49 7433 12-2696

www.bizerba.com

Bizerba USA Inc.

1804 Fashion Court
Joppa, MD 21085
USA

T Office +1 732 565-6000
T Service +1 732 565-6001
F +1 732 819-0429
us.info@bizerba.com

www.bizerba.com

Bizerba UK Limited

2-4 Erica Road
Stacey Bushes
Milton Keynes
Buckinghamshire
MK12 6HS
UK

T +44 1908 6827-40
F +44 1908 6827-77
sales@bizerba.co.uk

www.bizerba.com

Bizerba Canada Inc.

6411 Edwards Blvd
Mississauga
Ontario L5T2P7
Canada

T +1 888 240-3722
ca.info@bizerba.com

www.bizerba.ca

Bizerba Shanghai

Weigh Tech & Systems Co. Ltd.

Room 307, Building A
Shanghai Jiuxing Hongqiao
Business Center
NO.9 Shenbin Road
Shanghai
China

T +86 21 676009-99
F +86 21 676009-98
marketing.china@bizerba.cn

www.bizerba.cn

III/1000.60en © 2nd edition 082018. Subject to modifications.

Deviations in color, printing errors due to the photographic material or printing, or changes in construction and model are reserved.

Ceraclean® and Emotion® are registered trademarks of Bizerba SE & Co. KG in at least one EU country and in the USA.